

# 2024 Membership Directory and Buyer's Guide



**SHEET METAL AND AIR CONDITIONING  
CONTRACTORS' ASSOCIATION  
MID-ATLANTIC CHAPTER**

7833 Walker Drive, Suite 400, Greenbelt, Maryland 20770  
info@smacnaatl.org • www.smacnaatl.org  
301-446-0002



## Celebrating 40 Years!

**“The largest small company you will ever meet”**

Welcome to The Bowers Group, one of the Nation’s largest mechanical contractors located in the Washington, DC metro area. Since its inception in 1984, W.E. Bowers has provided superior mechanical construction and service to general contractors, high tech companies, property managers, government agencies and institutional clients throughout the Metropolitan region. Today, we offer our clients a wide range of services including new construction, tenant fit outs, design assist, critical facilities, data centers, retrofits, maintenance and emergency services. Our state-of-the-art CAD Department and Pre-Fabrication facilities allows us to provide our clients with top of the line efficiency and quality production.



**W.E. Bowers, Inc.**  
Mechanical Construction,  
Plumbing and HVAC Service  
12401 Kiln Court, Suite A  
Beltsville, MD, 20705  
Main: 301.419.2488  
Construction Fax: 301.419.2711  
Service Fax: 301.419.2310  
[www.webowers.com](http://www.webowers.com)

Sheet Metal  
and  
Air Conditioning Contractors'  
National Association

Mid-Atlantic Chapter

**MEMBERSHIP DIRECTORY  
&  
BUYER'S GUIDE  
2024**



OUR MISSION –

The SMACNA Mid-Atlantic Chapter is a professional organization representing HVAC and related industries that promotes quality products and services through a standard of technical excellence in technology, education and training.

---

Download **MemberPlus** App to access our digital directory, your profile, event registrations, and more.



App Store



Google Play



**MAC**  
MOBILE AIR CLEANER



Proudly Made In The  
**USA**  
Since 1941

# **HB** ENGINEERED PRODUCTS

*Proudly Representing*



**301-918-0241**

**WWW.HBPRODUCTS.COM**

**KEEP UP TO DATE WITH EVENTS -  
VISIT SMACNA MID-ATLANTIC'S WEBSITE:  
[www.smacnaatl.org](http://www.smacnaatl.org)**



**SMACNA MID-ATLANTIC CHAPTER**

7833 Walker Drive, Suite 400  
Greenbelt, MD 20770-3222

Phone: 301-446-0002  
Email: [info@smacnaatl.org](mailto:info@smacnaatl.org)  
Website: [www.smacnaatl.org](http://www.smacnaatl.org)

**Staff**

Kurt Snyder  
*Executive Director*  
[kurt@smacnaatl.org](mailto:kurt@smacnaatl.org)  
Ext. #1

Kelly Maltagliati  
*Office Manager*  
[info@smacnaatl.org](mailto:info@smacnaatl.org)  
Ext. #2

Bookkeeper/Financials  
[accounting@smacnaatl.org](mailto:accounting@smacnaatl.org)  
Ext. #3

# Upcoming SMACNA Events\* 2023 - 2024

## **The Big Three: Medley of Microsoft (Word, Excel, and Outlook)**

Virtual Training – Capital Contractors Institute  
December 6, 2023

## **Council of Chapter Representatives**

Scottsdale, AZ  
December 10 – 12, 2023

## **Collective Bargaining Orientation**

Tempe, AZ  
February 12 – 13, 2024

## **2024 Partners in Progress Conference**

Orlando, FL  
February 27 – 28, 2024

## **Association Leadership Meeting**

Irving, TX  
March 26 – 27, 2024

## **Council of Chapter Representatives**

Beaver Creek, CO  
June 2 – 4, 2024

## **2024 SMACNA Annual Convention**

Palm Desert, CA  
October 27 – 30, 2024

## **Council of Chapter Representatives**

New Orleans, LA  
December 8 – 10, 2024

## **2025 SMACNA Annual Convention**

Maui, HI  
October 26 – 29, 2025

## **2026 SMACNA Annual Convention**

Orlando, FL  
October 25 – 28, 2026

## **2027 SMACNA Annual Convention**

Chula Vista, CA  
October 24 – 27, 2027

**For more information, call 301-446-0002 or go to [www.smacnaatl.org](http://www.smacnaatl.org)**

\*Some dates and times may be subject to change.

# Table of Contents

	Page
Chapter Staff .....	3
Upcoming SMACNA Events .....	4
Board of Directors.....	7
Sheet Metal Industry Fund Trustees.....	8
Pension/Health Contractor Trustees.....	9
Joint Apprenticeship Training Committee .....	10
Trustees	
Important Phone Numbers .....	11-12
SMACNA National Staff.....	13-17
Industry Members.....	19
Associate Members .....	43
Alphabetical Personnel Index.....	61
Members by Business Specialty.....	67
Glossary of Industry Terms.....	73
Conversion Tables .....	96-97
Advertisers' Index .....	98

\* Associate members who are both national and chapter members

\*\* New members

# FERGUSON<sup>®</sup> HVAC

Ferguson HVAC is committed to providing you with the most comprehensive selection of HVAC equipment, parts and services in the industry. By providing strategically located distribution centers, advanced shipping technology, an ample inventory & top-notch customer service; we guarantee that you can **COUNT ON US.**

***For more information, call the location nearest you!***



A Southwire Company

Halethorpe, MD 410-247-4580  
 Capitol Heights, MD 301-808-3500  
 Chantilly, VA 703-818-8700  
 Alexandria, VA 703-236-2256



Original Corporation • An Ampco Oxide Company

Hagerstown, MD 301-745-5530  
 Rockville, MD 301-294-8501



Johns Manville

Westminister, MD 410-386-0584  
 White Plains, MD 301-396-8960



Annapolis, MD 410-573-6625



A Family Tradition Since 1928

White Marsh, MD 410-687-7980



SHEET METAL WORKING MACHINERY

Frederick, MD 301-378-7337

Woodbridge, VA 703-234-1099



Alexandria, VA 703-658-5124

Frederick, MD 301-378-7146



Winchester, VA 540-542-6670

Manassas, VA 571-778-6177



[www.fergusonhvac.com](http://www.fergusonhvac.com)  
[www.ferguson.com](http://www.ferguson.com)



## **CHAPTER OFFICERS & BOARD MEMBERS 2023-2024**

Dale Sheppard, President\*  
W.E. Bowers  
Term expires 2024

James Noto, Vice President\*  
Metro Test & Balance, Inc.  
Term expires 2024

Mary Patricia Suhr, Treasurer\*  
Stromberg Metal Works, Inc.  
Term expires 2024

Kathleen Bigelow, Past President  
Comfort Control, Inc.  
Term expires 2025

Dale Trunnell, Past President  
Metro Mechanical Contractors  
Term expires 2025

Michael Pantele  
R.S. Harritan & Company, Inc.  
Term expires 2026

Frank Roberts  
Southland Industries  
Term expires 2026

Bryan Malle  
Ample Sheet Metal, Inc.  
Term expires 2025

Nick Vendemia  
CMC Sheet Metal  
Term expires 2026

Derril Mackin  
Journeyman Mechanical Contractors  
Term expires 2026

*\*Denotes members of the Executive Committee*

## **RECENT PAST PRESIDENTS**

Geoff Parks 2020-2022  
CMC Sheet Metal

Kathleen Bigelow 2018-2020  
Comfort Control, Inc.

# SMACNA Mid-Atlantic Chapter

## Sheet Metal Industry Fund Trustees

Each Term is three years

### **Frank Battagino, Chair**

Metro Test & Balance, Inc.  
9600 Fallard Court  
Upper Marlboro, MD 20772  
Phone: 301-808-3660  
Email: frank@metrotestbalance.com  
Term Expires 2025

### **Frank Roberts, Secretary**

Southland Industries  
22340 Dresden Street, Suite 177  
Dulles, VA 20166  
Phone: 703-834-5570  
Email: froberts@southlandind.com  
Term Expires 2026

### **Kathleen Bigelow**

Comfort Control, Inc.  
6711 Distribution Drive  
Beltsville, MD 20705  
Phone: 301-931-9300  
Email: kbigelow@comfortcontrolbalance.com  
Term Expires 2026

### **William Gawne**

Stromberg Metal Works, Inc.  
6701 Distribution Drive  
Beltsville, MD 20705  
Phone: 301-931-1000  
Email: bgawne@strombergmetals.com  
Term Expires 2024

### **Dale Sheppard**

W.E. Bowers  
12401 Kiln Court, Suite A  
Beltsville, MD 20705  
Phone: 301-419-2488  
Email: dsheppard@webowers.com  
Term Expires 2026

### **Nick Vendemia**

CMC Sheet Metal  
1208 Marblewood Avenue  
Capitol Heights, MD 20743  
Phone: 301-925-4040  
Email: nvendemia@cmcsheetmetal.com  
Term Expires 2025

### **Mary Patricia Suhr**

Stromberg Metal Works, Inc.  
6701 Distribution Drive  
Beltsville, MD 20705  
Phone: 301-931-1000  
Email: tsuhr@strombergmetals.com  
Term Expires 2025

## **Pension/Health Contractor Trustees**

### **Washington, D.C.**

Frank Battaglino  
Metro Test & Balance, Inc.  
9600 Fallard Court  
Upper Marlboro, MD 20772

Kathleen Bigelow  
Comfort Control, Inc.  
6711 Distribution Drive  
Beltsville, MD 20705

Ian Duckworth  
CMC Sheet Metal  
1208 Marblewood Ave.  
Capitol Heights, MD 20743

Scott Gregory  
R. Scott Gregory  
329 Martins Cove Road  
Annapolis, MD 21409

Dale Sheppard  
W.E. Bowers  
12401 Kiln Court, Suite A  
Beltsville, MD 20705

## **Joint Apprenticeship Training (Contractor) Committee Trustees**

### **Washington, D.C.**

Rob Delawder, Chariman  
Southland Industries  
22340 Dresden Street  
Suite 177  
Dulles, VA 20166

Michael Gawne  
Stromberg Metal Works, Inc.  
6701 Distribution Drive  
Beltsville, MD 20705

Tim Aley  
W.E. Bowers  
12401 Kiln Court, Suite A  
Beltsville, MD 20705

Ian Duckworth  
CMC Sheet Metal  
1208 Marblewood Ave.  
Capitol Heights, MD 20743

### **Baltimore**

Stan Fleischer  
Seneca Balance of Maryland, Inc.  
2301 Willoughby Beach Road  
Edgewood, MD 21040

Bryan Malle  
Ample Sheet Metal, Inc.  
7501 Connelley Drive  
Suite A  
Hanover, MD 21076

## **IMPORTANT PHONE NUMBERS**

**(SMART)**

**International Association of Sheet Metal, Air,  
Rail and Transportation Workers  
Local Union 100**

Richie Labille, III, President & Business Manager  
4725 Silver Hill Road  
Suitland, MD 20746  
Phone: 301-568-8655  
Fax: 301-967-1683  
Email: [info@smart100.org](mailto:info@smart100.org)

Richmond Office:  
184 E. Belt Boulevard  
Richmond, VA 23224

Main Phone: 800-492-8004  
Option #1 - W.C. Earhart Funds Office  
Option #2 - Zenith American Funds Office  
Option #3 - Training Center  
Option #4 - Name Directory  
Option #5 - Dues Office  
Option #6 - For Further Assistance

### **International Training Institute**

Daniel McCallum  
3180 Fairview Park Drive  
Suite 400  
Falls Church, VA 22042  
Phone: 703-739-7200  
Fax: 703-683-7461  
Email: [dmccallum@sheetmetal-iti.org](mailto:dmccallum@sheetmetal-iti.org)  
Website: [www.sheetmetal-iti.org](http://www.sheetmetal-iti.org)

**SMACNA National**

4201 Lafayette Center Drive  
Chantilly, VA 20151  
Phone: 703-803-2980  
Fax: 703-803-3732

**SMACNA National – Capitol Hill Office**

305 4th Street, N.E.  
Washington, DC 20002  
Phone: 202-547-8202  
Fax: 202-547-8810

**Construction Labor Research Council**

1750 New York Avenue, NW  
West Lobby  
Washington, DC 20006  
Phone: 202-347-8440  
Fax: 202-347-8442  
clrc@clrc.biz

**Workplace Fraud Unit/  
Reporting Misclassification****State of Maryland –****Division of Labor and Industry**

1100 North Eutaw Street, Room 607  
Baltimore, MD 21201  
Phone: 410-767-9885  
wcpu@dllr.state.md.us

**Employer Services****D.C. Department of Employment Services**

4058 Minnesota Avenue, NE, Suite 5600  
Washington, DC 20019  
Phone: 202-671-0891

**North America's Building Trades Unions****Choice - Washington DC-Baltimore MD Region**

Kirk Brungard, Executive Director, EW  
815 16th St. NW, Suite 600  
Washington, DC 20006  
Phone: 202-756-4660

# SMACNA NATIONAL STAFF

	<b>Telephone Direct Dial</b>
<b><u>Executive Division</u></b>	
Aaron Hilger, Chief Executive Officer	(703) 803-2988
Joye Blanscett, Executive Director of Operations	(703) 803-2997
Deborah Forde, Executive Assistant	(703) 995-4028
Susannah Forde, Executive Director of Communications & Marketing	(703) 995-4022
Eli P. Howard, III, Executive Director of Technical Services	(703) 803-2995
Linda Jennings, Executive Director of Market Sectors & Construction Technology	(703) 995-4179
Stanley E. Kolbe, Jr., Executive Director of Government & Political Affairs	(202) 547-8202
Jason Watson, Executive Director of Labor Relations	(703) 803-2981
<b><u>Communications &amp; Marketing</u></b>	
Susannah Forde, Executive Director of Communications & Marketing	(703) 995-4022
Denise Ladd, Communications Specialist	(703) 995-4037
Seth Lennon, Manager, Communications	(703) 995-4033
Nabeelah Naeem, Director of Marketing	(703) 803-2998
Cody Shook, Manager, Social Media	(703) 995-4036
Ryley Trahan, Director, Digital Media	(703) 995-4029
<b><u>Labor Relations &amp; Human Resources</u></b>	
Jason Watson, Executive Director of Labor Relations	(703) 803-2981
Heather Frank, Admin. Assistant for Labor Relations	(703) 995-4045
Julie Marnell, Manager of Labor Relations	(703) 803-2980
Caroline McGraw, Labor Services Project Manager	(703) 803-2984
Maggie Powers, Asst. Director of Labor Relations	(703) 803-2994
Abbie Sanchez, Admin. Assistant for Labor Relations	(703) 803-2985

### **Legislative Department**

Stanley E. Kolbe, Jr., Executive Director  
of Government & Political Affairs (202) 547-8202  
Erica Anderson, Administrative Assistant,  
Legislative & Political Affairs (202) 547-8202  
Belén Pifel, Manager, Legislative &  
Political Affairs (202) 547-8202  
Megan Sawchek, Intern  
Capitol Hill Office (202) 547-8202  
Erykka Thompson, Assistant Director  
of Legislation (202) 547-8202

### **Market Sectors & Construction Technology**

Linda Jennings, Executive Director of  
Market Sectors & Construction Technology  
(703) 995-4179  
Justin Crandol, Director of Safety (703) 995-4027  
Sushma Dhakal, Admin. Assistant for  
Market Sectors & Construction Technology  
(703) 995-4178  
Travis Voss, Director of Innovative Technology,  
Market Sectors & Construction Technology  
(703) 803-2980

### **Meetings & Convention Department**

John G. Franco, Director of Meetings &  
Convention (703) 995-4023  
Kristin DeGuzman, Sr. Manager of Meetings &  
Convention (703) 803-2983  
Allison Gallagher, Meetings Assistant (703) 995-4026

### **Operations**

Joye Blanscett, Executive Director of  
Operations (703) 803-2997  
Valerie McLane, Project Specialist (703) 995-4047

### **Accounting Department**

Leila Sader, Controller (703) 995-4030  
Karen Curry, Accounting Assistant (703) 803-2982  
Sophorn Ke, General Ledger  
Accountant (703) 995-4031

### **Business Development & Member Relations**

Bridgette Bienacker, Sr. Director of Business  
Dev.& Member Relations (703) 803-2987  
Dustin Berger, Director of Member &  
Corporate Relations (703) 995-4180  
Shelly Dixon, Admin. Assistant (703) 995-4025  
Sara Mauck, Membership Coordinator &  
Publication Sales (703) 803-2991



### **Chapter Relations**

Jen Squirewell, Manager,  
Chapter Relations (703) 995-4032

### **Exhibitor Forum**

Bridgette Bienacker, Sr. Director of Business Dev.  
& Member Relations (703) 803-2987

### **Financial Services**

Leila Sader, Controller (703) 995-4030

### **Information Technology & Systems**

Tim Eads, Manager, Information  
Technology & Systems (703) 995-4034

### **Production & Operations**

David R. Rudd, Manager of  
Operations (703) 803-2999

### **Safety & Health**

Linda Jennings, Executive Director of Market Sectors  
& Construction Technology (703) 995-4179

Justin Crandol, Director of Safety (703) 995-4027

### **Technical Services**

Eli P. Howard, III, Executive Director of  
Technical Services (703) 803-2995

Scott Barr, Senior Project Manager (703) 803-2980

Patrick J. Brooks, Senior Project  
Manager (703) 803-2993

William Farrell, Senior Project  
Manager (703) 803-2980

Shawn OHara, Project Manager (703) 803-2992

Geoff Parks, Senior Project  
Manager (703) 803-2980



## **SMACNA NATIONAL STAFF E-MAIL AND TELEPHONE**

General Information	703-803-2980
Anderson, Erica eanderson@smacna.org	202-547-8202
Barr, Scott sbarr@smacna.org	703-803-2980
Berger, Dustin dberger@smacna.org	703-995-4180
Bienacker, Bridgette bbienacker@smacna.org	703-803-2987
Blanscett, Joye jblanscett@smacna.org	703-803-2997
Crandol, Justin jcrandol@smacna.org	703-995-4027
Curry, Karen kcurry@smacna.org	703-803-2982
De Guzman, Kristin kdeguzman@smacna.org	703-803-2983
Dhakal, Sushma sdhakal@smacna.org	703-995-4178
Dixon, Shelly sdixon@smacna.org	703-995-4025
Eads, Tim teads@smacna.org	703-995-4034
Farrell, William wfarrell@smacna.org	703-803-2980
Forde, Deborah dforde@smacna.org	703-995-4028
Forde, Susannah sforde@smacna.org	703-995-4022
Franco, John jfranco@smacna.org	703-995-4023
Frank, Heather hfrank@smacna.org	703-995-4045
Gallagher, Allison agallagher@smacna.org	703-995-4026
Hilger, Aaron ahilger@smacna.org	703-803-2988
Howard, Eli ehoward@smacna.org	703-803-2995
Jennings, Linda ljennings@smacna.org	703-995-4179
Ke, Sophorn ske@smacna.org	703-995-4031

Kolbe, Stan skolbe@smacna.org	202-547-8202
Ladd, Denise dladd@smacna.org	703-995-4037
Lennon, Seth slennon@smacna.org	703-995-4033
Marnell, Julie jmarnell@smacna.org	703-803-2980
Mauck, Sara smauck@smacna.org	703-803-2991
McGraw, Caroline cmcgraw@smacna.org	703-803-2984
McLane, Valerie vmclane@smacna.org	703-995-4047
Naeem, Nabeelah nnaeem@smacna.org	703-803-2998
OHara, Shawn sohara@smacna.org	703-803-2992
Parks, Geoff gparks@smacna.org	703-803-2980
Pifel, Belén bpifel@smacna.org	202-547-8202
Powers, Maggie mpowers@smacna.org	703-803-2994
Rudd, Randy rrudd@smacna.org	703-803-2999
Sader, Leila lsader@smacna.org	703-995-4030
Sanchez, Abbie asanchez@smacna.org	703-803-2985
Sawchek, Megan msawchek@smacna.org	202-547-8202
Shook, Cody cshook@smacna.org	703-995-4036
Squirewell, Jennifer jsquirewell@smacna.org	703-995-4032
Thompson, Erykka ethompson@smacna.org	202-547-8202
Trahan, Ryley rtrahan@smacna.org	703-995-4029
Voss, Travis tvoss@smacna.org	703-803-2980
Watson, Jason jwatson@smacna.org	703-803-2981

# CRAFTCORPS, INC.

Est. 1986



## We're serious about service.

CRAFTCORPS' Mid-Atlantic office, established in 1997, provides a wide variety of construction and crafts maintenance services tailored to meet the client's needs to keep their facility operating at peak performance. We've created long lasting successful relationships with clients in the area. Proudly partnering with SMACNA since 1997.

### SHEET METAL

- Sheet Metal Fabrication
- Cleanroom HVAC
- Scrubbed Acid Exhaust Systems
- Fiberglass Reinforced Plastic
- Custom Stainless Fabrication
- Facility Maintenance Support
- Commercial HVAC



VA Office  
217 W. Williamsburg Rd.  
Sandston, VA 23150  
804.737.9296

Corporate Headquarters  
3401 Manor Rd.  
Austin, TX 78723  
512.476.8886

[CRAFTCORPS.COM/MIDATLANTIC](http://CRAFTCORPS.COM/MIDATLANTIC)

# Industry Members

**\*\* New Member**

**- A -**

## **AMERICAN TESTING, INC.**

3220-F Corporate Court  
Ellicott City, MD 21042

**Phone:** 410-461-6211

**Fax:** 410-461-6274

**Website:** [www.americantesting.us](http://www.americantesting.us)

Christine Kelly

*President*

[ckelly@americantesting.us](mailto:ckelly@americantesting.us)

Michael Kelly

*Vice President*

[mkelly@americantesting.us](mailto:mkelly@americantesting.us)

Jeremy Johnson

*Operations Manager*

[jjohnson@americantesting.us](mailto:jjohnson@americantesting.us)

**Business Function(s):** Testing and Balancing,  
Commissioning, Indoor Air Quality, Stairwell  
Pressurization, Fumehood Certifications



## **AMPLE SHEET METAL, INC.**

*(see ad page 21)*

7501 Connelley Drive  
Hanover, MD 21076

**Phone:** 410-760-6401

**Fax:** 410-760-6365

**Website:** [www.amplesheetmetal.com](http://www.amplesheetmetal.com)

Bryan Malle

*Vice President*

Phone: 410-684-5691

Email: [bryan@amplesheetmetal.com](mailto:bryan@amplesheetmetal.com)

Kristi Yazel

*Office Manager*

Phone: 410-684-5682

Email: [kristi@amplesheetmetal.com](mailto:kristi@amplesheetmetal.com)

**Business Function(s):** Custom Fabrication, Industrial Sheet Metal, Commercial HVAC, Architectural HVAC

## **ARICA CONSULTING & CONTRACTING**

8309A Sherwick Court  
Jessup, MD 20794

**Phone:** 301-498-4441

**Fax:** 301-498-4003

**Email:** [info@aricaconsulting.com](mailto:info@aricaconsulting.com)

**Website:** [www.aricaconsulting.com](http://www.aricaconsulting.com)

Thomas Twigg

*President*

Email: [aricaconsulting@msn.com](mailto:aricaconsulting@msn.com)

**Business Function(s):** Custom AHU Manufacturing, Architectural Sheet Metal, Commercial HVAC, Custom Air Handling Units, Manufacturing (HVAC & Components), Ductwork Fabrication, Complete Mechanical



**Design Fabrication Installation**

**[www.amplesheetmetal.com](http://www.amplesheetmetal.com)**

7501 Connelley Drive, Hanover, MD 21076

**(410) 760-6401**

*Serving the tri-state area for over 48 years*

**Maryland • Washington • Delaware • Virginia**

*Ample is the only Union Sheet Metal Fabrication Facility Located in the Baltimore Jurisdiction*

***We have the honor of serving the following Clients***

All Government Facilities Local and Federal in the Tri-State Area • All Government Subcontractors • General-Use Offices • Multiple Military Bases • Special Military Installations • Embassies • Courthouses • National Laboratories • Research and Development • Museums • Medical Manufacturing • Schools and Colleges • Food Processing • Heritage and Historical sites

• **Ample** Maintains Multiple Security Clearances

### **Special Project Division**

*Design, Coordination, Model / Templating  
Developed of Custom Fabrication Material, 200  
Ton Press Break, Laser and Water Jet Cutting*

**SPECIALIZING IN COMMERCIAL & INDUSTRIAL  
DESIGN • FABRICATION • INSTALLATION**

***Since 1975***

**Bryan P. Malle - Vice President**

Direct (410) 684-5691

***Bryan@amplesheetmetal.com***

**Kristi Yazel - Office Manager**

Direct (410) 684-5682

***Kristi@amplesheetmetal.com***

Celebrating  
Over **40** Years

of Excellence and the Highest Quality  
Sheet Metal Fabrication and Installation

## Technology

... continually investing in leading  
edge fabrication equipment.

## Innovation

... a creative structure encourages  
innovative thinking at every level.

## Quality

... CMC Advantage results in a higher  
level of quality for each dollar spent.

## Ability

... we instill a passion for doing the  
best work, everyday, at every level.

## Professionals

... from estimating to installing, you will find  
CMC professionals at every phase of your project.



301-925-4040

1208 MARBLEWOOD AVE | CAPITOL HEIGHTS, MD 20743



## CMC SHEET METAL

(see ad on page 22)

1208 Marblewood Avenue, Capitol Heights, MD 20743

**Phone:** 301-925-4040

**Fax:** 301-925-9598

**Website:** [www.cmcsheetmetal.com](http://www.cmcsheetmetal.com)

Don Hammond

*President/CEO*

Email: [dhammond@cmcsheetmetal.com](mailto:dhammond@cmcsheetmetal.com)

Gary St. John

*Controller*

Email: [gstjohn@cmcsheetmetal.com](mailto:gstjohn@cmcsheetmetal.com)

Steve Nickerson

*Vice President*

Email: [snickerson@cmcsheetmetal.com](mailto:snickerson@cmcsheetmetal.com)

Nick Vendemia

*Vice President/Project Management*

Email: [nvendemia@cmcsheetmetal.com](mailto:nvendemia@cmcsheetmetal.com)

Randy Ramey

*Vice President/Pre-Construction*

Email: [rramey@cmcsheetmetal.com](mailto:rramey@cmcsheetmetal.com)

Bill Fowble

*Field Superintendent*

Email: [wfowble@cmcsheetmetal.com](mailto:wfowble@cmcsheetmetal.com)

Billy Neilson

*Shop Superintendent*

Email: [wneilson@cmcsheetmetal.com](mailto:wneilson@cmcsheetmetal.com)

Alan Mozingo

*Project Manager*

Email: [amozingo@cmcsheetmetal.com](mailto:amozingo@cmcsheetmetal.com)

Ian Duckworth

*Project Manager*

Email: [iduckworth@cmcsheetmetal.com](mailto:iduckworth@cmcsheetmetal.com)

Ron Hutchison

*Project Manager*

Email: [rhutchison@cmcsheetmetal.com](mailto:rhutchison@cmcsheetmetal.com)

Maleeta Dailey

*Safety Director*

Email: [mdailey@cmcsheetmetal.com](mailto:mdailey@cmcsheetmetal.com)

**Business Function(s):** Commercial HVAC, Custom Fabrication (Rectangle, Round Spiral), Installation

## COMFORT CONTROL, INC.

(see ad on page 25)

6711 Distribution Drive  
Beltsville, MD 20705

**Phone:** 301-931-9300

**Fax:** 301-931-0369

**Website:** [www.comfortcontrolbalance.com](http://www.comfortcontrolbalance.com)

**General Email:** [cci@comfortcontrolbalance.com](mailto:cci@comfortcontrolbalance.com)

Kathleen Bigelow

*CEO*

Cell: 240-876-5486

Email: [kbigelow@comfortcontrolbalance.com](mailto:kbigelow@comfortcontrolbalance.com)

Darren R. Aley

*Vice President of Supervision/Manpower*

Cell: 240-417-0377

Email: [daley@comfortcontrolbalance.com](mailto:daley@comfortcontrolbalance.com)

Michael P. Moran

*Vice President of Estimation*

Email: [mmoran@comfortcontrolbalance.com](mailto:mmoran@comfortcontrolbalance.com)

Thomas W. Menefee

*Supervisor*

Cell: 240-417-0377

Email: [tmenefee@comfortcontrolbalance.com](mailto:tmenefee@comfortcontrolbalance.com)

Jamie P. Palermo

*Chief Project Officer*

Cell: 240-388-2487

Email: [jpalermo@comfortcontrolbalance.com](mailto:jpalermo@comfortcontrolbalance.com)

**Business Function(s):** Testing & Balancing, Sound & Vibration, Commercial HVAC Service, Residential Heating & Air Conditioning, Commissioning

## CRAFTCORPS, INC.

(see ad on page 18)

217 W. Williamsburg Road  
Sandston, VA 23150

**Phone:** 804-737-9296

**Fax:** 804-737-9297

**Website:** [www.craftcorps.com](http://www.craftcorps.com)

Jason Weatherby

*Area Operations Director*

Cell: 703-717-3550

Email: [jweatherby@craftcorpstva.com](mailto:jweatherby@craftcorpstva.com)

**Business Function(s):** Commercial HVAC, Industrial Sheet Metal



*Comfort Control Inc.*

[www.comfortcontrolbalance.com](http://www.comfortcontrolbalance.com)

**Main Office**

6711 Distribution Drive  
Beltsville, Maryland 20705  
Phone (301) 931-9300  
Fax (301) 931-0369

**Raleigh Branch Office**

228 Page Road Ste. 101  
Durham, North Carolina 27703  
Phone (919) 381-5065  
Fax (919) 381-5095



**- D -**

**DENSEL COMPANY, INC.**

7640-A Airpark Road  
Gaithersburg, MD 20879

**Phone:** 301-670-0970

**Fax:** 301-840-9705

**Website:** [www.densel.com](http://www.densel.com)

Bryan Austin

*President*

Email: [baustin@densel.com](mailto:baustin@densel.com)

**Business Function(s):** Commercial HVAC

– E –

**ENVIRONMENTAL BALANCING CORP.**

401 Carroll Street, Suite 102  
La Plata, MD 20646

**Phone:** 301-868-6334

Ray Hardesty  
Email: ray@envbalancingcorp.com

**Business Function(s):** Testing and Balancing

– I –

**I & B ASSOCIATES, INC.**

6925 4th Street NW, Unit 201  
Washington, DC 20012

**Phone:** 202-269-2761

**Fax:** 202-269-2762

**Website:** www.iandbassociates.com

Harvey Brackett  
*President*  
Email: iandbassociates1@gmail.com

James Ingram  
*Vice President*  
Cell: 301-440-0457  
Email: iandbassociates1@gmail.com

**Business Function(s):** Commercial HVAC

– J –

**JAMES MYERS COMPANY, INC.**

12306 Conway Road  
Beltsville, MD 20705

**Phone:** 301-419-0091

**Fax:** 301-419-3097

**Website:** www.jamesmyersco.com

Richard Myers  
Email: rmyers@jamesmyersco.com

**Business Function(s):** Architectural Sheet Metal

# JOURNEYMAN MECHANICAL CONTRACTORS

2125 Baldwin Avenue, Ste 19B  
Crofton, MD 21114

**Phone:** 301-261-6200

**Fax:** 301-261-0406

**Website:** [www.journeyman-mechanical.com](http://www.journeyman-mechanical.com)

Derril Mackin

*President*

Email: [DMackin@journeyman-mechanical.com](mailto:DMackin@journeyman-mechanical.com)

Tony Stapleton

*Project Manager*

Email: [TonyS@journeyman-mechanical.com](mailto:TonyS@journeyman-mechanical.com)

**Business Function(s):** Commercial, HVAC, Industrial Sheet Metal, Duct Construction, Commercial & Industrial Piping



## MECCO, LLC

10545 Guilford Road, Suite 105  
Jessup, MD 20794

**Phone:** 301-953-7600

**Fax:** 301-953-7667

**Email:** [info@meccoinc.net](mailto:info@meccoinc.net)

**Website:** [www.meccoinc.net](http://www.meccoinc.net)

Chris Castle

*President*

Email: [ccastle@meccoinc.net](mailto:ccastle@meccoinc.net)

Dan Wells

*Vice President*

Email: [dwells@meccoinc.net](mailto:dwells@meccoinc.net)

Steve Mack

*Director of Construction Operations*

Email: [smack@meccoinc.net](mailto:smack@meccoinc.net)

**Business Function(s):** Commercial HVAC, HVAC Products and Supplies

# METRO MECHANICAL CONTRACTORS

5611 Lafayette Place  
Hyattsville, MD 20781

Phone: 301-927-4077  
Fax: 301-927-4523

Dale Trunnell  
*President*

Email: [dtrunnell@metromechllc.com](mailto:dtrunnell@metromechllc.com)

Vic Anderson

Email: [vanderson@metromechllc.com](mailto:vanderson@metromechllc.com)

**Business Function(s):** Duct Construction



2023 Sporting Clays Event

# METRO TEST & BALANCE, INC.

9600 Fallard Court  
Upper Marlboro, MD 20772

**Phone:** 301-808-3660

**Fax:** 301-808-4216

**Website:** [www.metrotestbalance.net](http://www.metrotestbalance.net)

Frank W. Battaglino

*President*

Email: [frank@metrotestbalance.com](mailto:frank@metrotestbalance.com)

James Noto

*Vice President*

Email: [james@metrotestbalance.com](mailto:james@metrotestbalance.com)

Frank L. Battaglino

*Lead Sheet Metal Estimating*

Email: [franklouis@metrotestbalance.com](mailto:franklouis@metrotestbalance.com)

Gabriel J. Battaglino

*Project Manager/Sheet Metal*

Email: [gabe@metrotestbalance.com](mailto:gabe@metrotestbalance.com)

Rick Richardson

*Project Manager/Sheet Metal*

Email: [rick@metrotestbalance.com](mailto:rick@metrotestbalance.com)

Robert Hagmann

*Project Manager/Sheet Metal*

Email: [rhagmann@metrotestbalance.com](mailto:rhagmann@metrotestbalance.com)

Jim Hahr

*Superintendent/Sheet Metal*

Email: [jhahr@metrotestbalance.com](mailto:jhahr@metrotestbalance.com)

Billy Robbins

*Director TAB Operations*

Email: [billy@metrotestbalance.com](mailto:billy@metrotestbalance.com)

Chris Robbins

*Project Manager TAB*

Email: [chris@metrotestbalance.com](mailto:chris@metrotestbalance.com)

Jason Brewer

*Project Manager TAB*

Email: [jason@metrotestbalance.com](mailto:jason@metrotestbalance.com)

John Pierce

*Project Manager TAB*

Email: [jpierce@metrotestbalance.com](mailto:jpierce@metrotestbalance.com)

**Business Function(s):** Aeroseal Duct Sealing, Commercial HVAC, Services, Testing and Balancing, Sound & Vibration, IAQ, Fire Life Safety Commercial, Institutional HVAC Sheet Metal



## **NORAIR ENGINEERING ASSOCIATES**

337 Brightseat Road, Suite 200  
Landover, MD 20785

**Phone:** 301-499-2202

**Fax:** 301-499-1342

**Website:** [www.norair.com](http://www.norair.com)

Richard Norair

*President*

Email: [rnorair@norair.com](mailto:rnorair@norair.com)

**Business Function(s):** Commercial HVAC, Industrial Sheet Metal



## **PENN AIR CONTROL, INC.**

5941 Lakeshore Drive  
Cypress, CA 90630

**Phone:** 714-220-9091

**Website:** [www.pennairgroup.com](http://www.pennairgroup.com)

Corporate Office:

7401 Hull Street Road, Unit 100-2  
N. Chesterfield, VA 23235

Gina Medel

*Chief Financial Officer*

Email: [ginam@pennairgroup.com](mailto:ginam@pennairgroup.com)

Alex Miranda

*Sales Executive*

Phone: 714-305-1881

Email: [amiranda@pennairgroup.com](mailto:amiranda@pennairgroup.com)

Miguel Rodriguez

*Test & Balance Engineer*

Phone: 787-504-8118

Email: [mrodriguez@pennairgroup.com](mailto:mrodriguez@pennairgroup.com)

**Business Functions(s):** Testing & Balancing of HVAC Systems, HVAC Cleaning and Sanitizing, Indoor Air Quality Investigation



## **PTL CONTRACTING, LLC**

8411 Old Marlboro Pike, Unit 24  
Upper Marlboro, MD 20772

**Phone:** 202-497-0113

**Fax:** 301-420-5788

David Boo

*President*

Email: david@djbcontracting.com

Sam Boo

*Bookkeeper*

Email: sam@djbcontracting.com

**Business Functions(s):** Roofing, Masonry  
Restoration, Curtainwall Restoration

**- R -**

## **R.S. HARRITAN & COMPANY, INC. MECHANICAL CONTRACTORS**

An EMCOR Company

3280 Formex Road - P.O. Box 24157  
Richmond, VA 23224

**Website:** [www.rsharritan.com](http://www.rsharritan.com)

Mike Pantele

*President*

Direct: 804-727-7805

Cell: 804-640-4610

Direct Fax: 866-240-6031

Email: mike\_pantele@emcorgroup.com

Vacant

*Sheet Metal Division Manager*

**Business Function(s):** Commercial HVAC, Custom  
Fabrication, Industrial Sheet Metal, Commercial  
& Industrial Piping, Structural Steel, Millwright  
Equipment Installation

## – S –

### **SENECA BALANCE OF MARYLAND, INC.**

2301 Willoughby Beach Road  
Edgewood, MD 21040

**Phone:** 800-938-2252

**Fax:** 410-665-2985

Stan Fleischer

*President*

Email: StanF@senecabalance.com

**Business Function(s):** Air Testing and Balancing

### **SOUTHLAND INDUSTRIES**

**Engineering/ Construction Office:**

*(see ad on page 33)*

22340 Dresden Street

Suite 177

Dulles, VA 20166

**Construction Office:**

13150 Mid-Atlantic Blvd.

Suite 200

Laurel, MD 20708

**Phone:** 703-834-5570

**Fax:** 703-834-5572

James Meacham

*Vice President*

Email: jmeacham@southlandind.com

Rob Delawder

*Construction Manager*

Email: rdelawder@southlandind.com

Matt Bruening

*Operations Manager*

Email: mbruening@southlandind.com

Jamie Devan

*Safety Director*

Email: jdevan@southlandind.com

Frank Roberts

*Sheet Metal Superintendent*

Email: froberts@southlandind.com

**Business Function(s):** Full MEP Engineering and Construction Services

***Cover photo by Amanda Barnes.***



Southland Industries proudly supports:

# SMACNA

As an MEP building systems expert, Southland Industries provides integrated, full lifecycle solutions that optimize the design, construction, operation, and efficiency of buildings. Through collaborative partnerships with our clients and the collective expertise of our people, we create premier built environments and future-ready spaces where communities and businesses can thrive.

---

## MID-ATLANTIC

22340 Dresden Street,  
Suite 177,  
Dulles, VA 20166  
O: 703.834.5570  
P: 800.613.6240  
[southlandind.com](http://southlandind.com)



## **STROMBERG METAL WORKS, INC.**

*(see ad on the back cover)*

6701 Distribution Drive  
Beltsville, MD 20705

**Phone:** 301-931-1000

**Fax:** 301-931-1020

**Website:** [www.strombergmetals.com](http://www.strombergmetals.com)

Mary Patricia Suhr

*Chief Financial Officer*

Email: [tsuhr@strombergmetals.com](mailto:tsuhr@strombergmetals.com)

William Gawne

*Chief Operations Officer*

Email: [bgawne@strombergmetals.com](mailto:bgawne@strombergmetals.com)

Billy Blank

*Regional Manager - Preconstruction*

Email: [bblank@strombergmetals.com](mailto:bblank@strombergmetals.com)

Steve Elliott

*Manager of Project Managers and Sketching*

Email: [selliott@strombergmetals.com](mailto:selliott@strombergmetals.com)

Pat Ray

*Outside Superintendent*

Email: [pray@strombergmetals.com](mailto:pray@strombergmetals.com)

Chris Reynolds

*Shop Superintendent*

Email: [creynolds@strombergmetals.com](mailto:creynolds@strombergmetals.com)

Justin Valdisera

*Purchasing*

Email: [jvaldisera@strombergmetals.com](mailto:jvaldisera@strombergmetals.com)

William Mould

*Safety Director*

Email: [bmould@strombergmetals.com](mailto:bmould@strombergmetals.com)

**Business Function(s):** Architectural Sheet Metal,  
Commercial HVAC, Duct Construction

## **STROMBERG METAL WORKS, INC.**

Architectural Plant

6700-A Distribution Drive  
Beltsville, MD 20705

**Phone:** 301-931-2070

**Fax:** 301-931-1021

Joe Puckett

*Architectural Estimator*

Email: [jpuckett@strombergmetals.com](mailto:jpuckett@strombergmetals.com)

Michael Gawne

*General Manager-Specialty/Architectural Division*

Email: [mgawne@strombergmetals.com](mailto:mgawne@strombergmetals.com)

## **STROMBERG METAL WORKS, INC.**

Baltimore Office  
803 Barkwood Court  
Linthicum, MD 21090

**Phone:** 410-589-5521

**Fax:** 410-589-5471

Andrew Parsons

*General Manager – Baltimore Division*

Email: [aparsons@strombergmetals.com](mailto:aparsons@strombergmetals.com)

## **STROMBERG METAL WORKS, INC.**

North Carolina Office  
6701 Fleetwood Drive  
Raleigh, NC 27612

**Phone:** 919-781-2515

Billy Blank

*General Manager – North Carolina Division*

Email: [bblank@strombergmetals.com](mailto:bblank@strombergmetals.com)



# SMACNA Mid-Atlantic Fishing Event





## **W.E. BOWERS**

*(see ad on the inside front cover & page 41)*

### **Headquarters:**

12401 Kiln Court, Suite A  
Beltsville, MD 20705

### **Virginia Mission Critical Offices:**

22740 Ladbrook Drive, Suite 100  
Sterling, VA 20166

### **Sheet Metal Offices and Shops:**

7101 Muirkirk Road  
Beltsville, MD 20705

22740 Ladbrook Drive, Suite 300  
Sterling, VA 20166

### **HVAC Piping and Plumbing Offices and Shops:**

12201 Conway Road  
Beltsville, MD 20705

12116 Conway Road  
Beltsville, MD 20705

### **Warehouse, Offices, Modular & Offsite Construction:**

6800 Distribution Drive  
Beltsville, MD 20705

**Phone:** 301-419-2488

**Fax:** 301-419-2711

**Website:** [www.webowers.com](http://www.webowers.com)

Wayne Bowers

*CEO*

Email: [wbowers@webowers.com](mailto:wbowers@webowers.com)

Kenny Colburn

*President*

Email: [kcolburn@webowers.com](mailto:kcolburn@webowers.com)

Dave O'Donnell

*President*

Email: [dodonnell@webowers.com](mailto:dodonnell@webowers.com)

Scott Sheppard

*Executive Vice President*

Email: [ssheppard@webowers.com](mailto:ssheppard@webowers.com)

Dale Sheppard  
*Vice President*  
Email: dsheppard@webowers.com

Tim Aley  
*Vice President*  
Email: taley@webowers.com

Arnold Weiss  
*Safety Director*  
Email: aweiss@webowers.com

Paul Cruz  
*Loss Prevention Manager*  
Email: pcruz@webowers.com

Craig Jordan  
*Sheet Metal Superintendent*  
Email: cjordan@webowers.com

Charles Adair  
*Service Coordinator*  
Email: cadair@webowers.com

Jason Willoughby  
*Sheet Metal Superintendent*  
Email: jwilloughby@webowers.com

Chris Bryant  
*Sheet Metal Superintendent*  
Email: cbryant@webowers.com

Jason Simpson  
*Sheet Metal Superintendent*  
Email: jsimpson@webowers.com

George Roberts  
*Sheet Metal Superintendent*  
Email: groberts@webowers.com

Paul Finch  
*Sheet Metal Shop Foreman - Beltsville*  
Email: pfinch@webowers.com

Darrell Wade  
*Sheet Metal Shop Foreman - Sterling*  
Email: dwade@webowers.com

Kenny Whiting  
*Sheet Metal Pickoff and Duct Sales*  
Email: kwhiting@webowers.com



Vince McGowan  
*Sheet Metal Senior Estimator*  
Email: vmcgowan@webowers.com

John Maddy  
*Sheet Metal Senior Estimator*  
Email: jmaddy@webowers.com

Robert Gatton  
*Sheet Metal Lead Estimator*  
Email: rgatton@webowers.com

Travis Brissey  
*Sheet Metal Lead Estimator*  
Email: tbrissey@webowers.com

Kevin McMaster  
*Sheet Metal Estimator/Project Manger*  
Email: kmcmaster@webowers.com

Jacob McCartin  
*Sheet Metal Estimator/Project Manager*  
Email: jmccartin@webowers.com

Mike Stauffer  
*Sheet Metal Project Executive*  
Email: mstauffer@webowers.com

Rick Longfellow  
*Sheet Metal Senior Project Manager*  
Email: rlongfellow@webowers.com

Cody Cain  
*Sheet Metal Project Manager*  
Email: ccain@webowers.com

Ervin Taylor  
*Sheet Metal Senior Project Manager*  
Email: etaylor@webowers.com

Eric Smith  
*Sheet Metal Project Manager*  
Email: esmith@webowers.com

Gary Baker  
*Sheet Metal Project Manager*  
Email: gbaker@webowers.com

Greg Brakeall  
*Sheet Metal Project Manager*  
Email: gbrakeall@webowers.com

Jack Parker  
*Sheet Metal Project Manager*  
Email: jparker@webowers.com

Stewart Gibson  
*Sheet Metal Project Manager*  
Email: sgibson@webowers.com

Daniel White  
*Sheet Metal Coordination Manager*  
Email: dwhite@webowers.com

Scott Riggs  
*S.M. Purchasing, Trucking, Warehouse &  
Tool Room Manager*  
Email: sriggs@webowers.com

**Business Function(s):** Commercial Mechanical Contractor, Service, Industrial, Rectangular Fabrication, Round and Spiral Fabrication, Manufacturing HVAC and Related Components



W.E. Bowers - Sterling, VA

# THE **BOWERS**

---

## GROUP

Our mission is to provide solutions—  
instead of just products—and to deliver  
superior service

Established in 1984, W.E. Bowers has served the mechanical construction, service, and repair needs of clients throughout Maryland, Virginia, and Washington, D.C. for 40 years.

Our clients include general contractors, high-tech firms, hospitals and institutional clients, government agencies, and property management companies.

We undertake every project as a team with the owner, general contractor, and architect/engineer. We strive to provide quality, cost efficiency and reliability for each project while creating an environmentally safe atmosphere.

We are extremely detailed in our equipment selection, drawing reviews, and monitoring of subcontractor performance, identifying potential delays and resolving them before they become a problem.

### **Markets Served and Services Provided**

Base Building  
Commercial Service  
Healthcare  
Mission Critical: New Construction  
Mission Critical: Retrofit & Service  
Service Construction  
Tenant  
Sheet Metal  
CADD/BIM Coordination  
Quality Control and Commissioning  
Speciality Piping Prefabrication  
Steel Piping Prefabrication  
Modular & Offsite Construction

# **NB HANDY**

**THE PREFERRED CHOICE SINCE 1891**

A LEADING WHOLESALE DISTRIBUTOR OF COMMERCIAL HVAC PRODUCTS AND MACHINERY

## **BRANCH LOCATIONS THROUGHOUT THE MID-ATLANTIC**

### **Rosedale, MD**

9003 Yellow Brick Rd.,  
Suite P  
Rosedale, MD 21237, USA  
(800) 759-6242

### **Lynchburg, VA**

3105 Odd Fellows Rd  
Lynchburg, VA 24501  
(800) 925-6242

### **Norfolk, VA**

4840 Brookside Ct,  
Ste 100  
Norfolk, VA 23502  
(800) 283-6242

### **Hanover, MD**

7495 Race Road  
Hanover, MD 21076  
(800) 234-6242

### **Roanoke, VA**

2836 Mary Linda Ave  
Roanoke, VA 24012  
(800) 289-6242

### **Richmond, VA**

7437 Ranco Rd  
Richmond, VA 23228  
(800) 288-6242

## **COMMERCIAL HVAC PRODUCT LINES**

### **Bath Fans**

Air King  
Broan  
Panasonic  
Delta Breeze  
Solar Palau

### **Commercial Fabrication & Fire Safety**

Aerodyne  
Caddy  
Cecco  
Ductmate  
Duro Dyne  
Mid West Metal Products  
Sheet Metal Connectors  
Acudor  
Aire Technologies  
Lloyd Industries  
NCA  
MetalFab  
Kees

### **Furnace Pipe/Fittings/B Vent**

Lukjan  
Greenseam

### **Grills, Registers, and Diffusers**

U.S. Aire  
MetalFab

### **HVAC Equipment and Ductless**

Allied Commercial  
Concord  
Samsung

### **HVAC Insulation & Flexible Duct**

Johns Manville  
Kflex  
Covertech  
Reflectix  
3M Fire Wrap  
QuietFlex

### **HVAC Machinery**

Duro Dyne  
Engel Flagler  
Gary  
Haco  
Iowa Precision  
ISM  
LockFormer  
Namcor Norlok  
Roto-Die  
Tennsmith  
Trilogy

### **Sealers and Adhesives**

Design Polymerics  
Ductmate  
Duro Dyne  
Polymer Adhesives

### **Steel Coil/Sheet**

48" & 60" coils  
36", 48" 120" sheets  
Variety of slit coil options  
Perforated  
Stainless Steel  
Aluminum  
Galvanneal  
Galvalume  
Black Iron

\*\*\*Complete product listing may not be available in all locations.

📞 800.284.6242

🌐 WWW.NBHANDY.COM

# Associate Members

\*Represents Associate Members who are both  
Chapter and National Members

\*\* New Member

## — A —

### AMERICAN METAL GOODS, INC.

6701 Distribution Drive  
Beltsville, MD 20705

**Phone:** 301-937-8069

**Fax:** 301-937-8954

**Website:** [www.americanmetalgoods.com](http://www.americanmetalgoods.com)

Warehouse Address:

12028A Old Baltimore Pike  
Beltsville, MD 20705

Warehouse/Sales/Purchasing

Email: [sales-purchasing@americanmetalgoods.com](mailto:sales-purchasing@americanmetalgoods.com)

Accounting/Customer Service

Email: [sbigelow@americanmetalgoods.com](mailto:sbigelow@americanmetalgoods.com)

**Business Function(s):** Commercial HVAC, Diffusers,  
Louvers, Supplies & Components

### ARROW UNITED INDUSTRIES

*(see Mestek Commercial Damper Louver Group  
page 53)*

## — C —

### CADVANTAGE DRAFTING SERVICE, INC.\*

2212 1st Avenue South  
St. Petersburg, FL 33712

**Phone:** 727-321-2072

**Fax:** 727-327-5159

**Website:** [www.cadvantagedrafting.com](http://www.cadvantagedrafting.com)

Daniel Sinclair

*President*

Email: [dsinclair@cadvantagedrafting.com](mailto:dsinclair@cadvantagedrafting.com)

Mary Sinclair

*Secretary/Treasurer*

Email: [msinclair@cadvantagedrafting.com](mailto:msinclair@cadvantagedrafting.com)

**Business Function(s):** Drafting/Design/BIM Services

## **CAMDEN YARDS STEEL COMPANY**

2500 Broadway  
Camden, NJ 08104-2409

**Phone:** 856-342-7100

**Website:** [www.camdenyardssteel.com](http://www.camdenyardssteel.com)

Michael Amato, Sr.  
*CEO*

Alan Kanoff  
*President*

Eric Engels  
*Sales Manager*  
Cell: 781-548-9315  
Email: [eengels@camdenyardssteel.com](mailto:eengels@camdenyardssteel.com)

**Business Functions(s):** Distributors & Processors of Carbon Flat Rolled Steel Sheet Metal, Plate, Coil & Slit Coil (galvanized, HR, galvanneal, CR, etc.)

## **CAPITAL ENERGY EQUIPMENT, INC.**

*(see ad on page 66)*  
232 Dominion Road, NE  
Vienna, VA 22180

**Phone:** 703-437-8161

**Email:** [Info@capitalenergyequipment.com](mailto:Info@capitalenergyequipment.com)

**Website:** [www.capitalenergyequipment.com](http://www.capitalenergyequipment.com)

Linda Shahryary  
*President*

Tom Shahryary  
*Vice President*  
Email: [Tom@CapitalEnergyEquipment.com](mailto:Tom@CapitalEnergyEquipment.com)

Andrew So  
Email: [andrew@capitalenergyequipment.com](mailto:andrew@capitalenergyequipment.com)

Kian Shahryary  
Email: [kian@capitalenergyequipment.com](mailto:kian@capitalenergyequipment.com)

**Business Function(s):** Spiral Duct, GRIPPLE Products, Air-Ynx Constant Airflow Regulators, Acoustical Panels, air outlets, louvers, sound attenuators, UL Dampers, Ceiling Radiation dampers, VAV Diffusers, Air terminals, BIBO HEPA Systems, Remote Cable Operated Dampers, Fabric Duct, Vehicle Exhaust & Snorkel Systems, Flue & Vent Systems, FANS

**COHEN SEGLIAS PALLAS  
GREENHALL & FURMAN PC**

900 Seventh Street, NW Suite 725  
Washington, DC 20001

1600 Market Street  
32nd Floor  
Philadelphia, PA 19103

**Phone:** 202-466-4110

**Fax:** 202-466-2693

**Website:** [www.cohenseglias.com](http://www.cohenseglias.com)

Roy Cohen

*Partner*

Email: [rcohen@cohenseglias.com](mailto:rcohen@cohenseglias.com)

Ed Seglias

*Partner*

Email: [eseglias@cohenseglias.com](mailto:eseglias@cohenseglias.com)

Jackson Nichols

*Partner*

Email: [jnichols@cohenseglias.com](mailto:jnichols@cohenseglias.com)

**Business Function(s):** Legal representation within the construction industry, Construction Law



2023 Sporting Clays Event

## **DUCTMATE INDUSTRIES\***

*(see ad page 47)*

210 Fifth Street  
Charleroi, PA 15022

**Phone:** 724-258-0500

**Fax:** 724-258-5494

**Toll Free:** 800-245-3188

**Email:** orders@ductmate.com

**Website:** www.ductmate.com

John Sorna

*Regional Channel Manager*

Cell: 240-626-1394

Email: jsorna@ductmate.com

Ray Yeager

*President*

**Business Function(s):** HVAC Components  
Manufacturer

## **DURO DYNE CORPORATION**

81 Spence Street  
Bay Shore, NY 11706

**Phone:** 631-249-9000

**Fax:** 631-249-8346

**Toll Free:** 800-899-3876

**Website:** www.durodyne.com

Rich Solimani

*Territory Manager*

Cell: 910-515-2099

Email: rsolimani@durodyne.com

Patrick Rossetto

*President*

Email: prosetto@durodyne.com

**Business Function(s):** HVAC Products and  
Supplies, Industrial Sheet Metal, Metal Sheets, Sheet  
Metal Supplies



# ULTIMATE ADVANTAGE

For When You Need It The Most



When life safety and building performance are your number one priority, Ductmate's ULtimate™ grease duct access doors are superior to the competition.

- Superior Life Safety Protection
- UL 1978 Listed
- Grease and Liquid Tight
- Meets NFPA 96 Standards
- 11 ga. 304SS or Black Iron
- No Tools/Quick and Easy Access
- ICC Tested with Leading Wraps
- Reduces Installation Time
- Custom Size Options Available



Learn More At [Ductmate.com](http://Ductmate.com)

**FEDERATED INSURANCE COMPANY\***

P.O. Box 328  
Owatonna, MN 55060

**Phone:** 800-533-0472

**Website:** [www.federatedinsurance.com](http://www.federatedinsurance.com)

John W. Medo  
*Field Manager*  
Cell: 317-432-3325  
Email: [jwmedo@fedins.com](mailto:jwmedo@fedins.com)

**Business Function(s):** Business Insurance, Life & Disability Insurance

**FERGUSON HVAC – LYON CONKLIN  
& CO. – OLD DOMINION SUPPLY**

*(see ad on page 6 & Old Dominion listing on page 55)*  
4501 Hollins Ferry Road  
Suite 140  
Halethorpe, MD 21227

**Phone:** 410-540-2800

**Fax:** 301-808-1408

**Website:** [www.ferguson.com](http://www.ferguson.com)

John Greene  
*Area Manager*  
Cell: 301-399-6459  
Email: [john.greene@ferguson.com](mailto:john.greene@ferguson.com)

Ryan Nunemaker  
*Sales Manager*  
Cell: 301-305-4920  
Email: [ryan.nunemaker@ferguson.com](mailto:ryan.nunemaker@ferguson.com)

**Business Function(s):** HVAC Components & Equipment, Manufacturer's Representatives

**GEORGETOWN INSURANCE  
SERVICE  
an ALERA GROUP COMPANY**

10010 Colesville Road, Ste. A  
Silver Spring, MD 20901

**Phone:** 301-681-9645  
**Fax:** 301-595-2590  
**Toll Free:** 800-842-2750

5300 Westview Drive, Ste. 106  
Frederick, MD 21703  
Email: [insurance@georgetownins.com](mailto:insurance@georgetownins.com)

Matt Simmons  
Email: [matt@georgetownins.com](mailto:matt@georgetownins.com)  
Cell: 301-706-2411

Patti Maluchnik  
Email: [pattis@georgetownins.com](mailto:pattis@georgetownins.com)

**Business Function(s):** Insurance, Bonding, Builders  
Risk, Captive Strategies, Benefits



Photo provided by  
H&B Engineered Products, Inc.

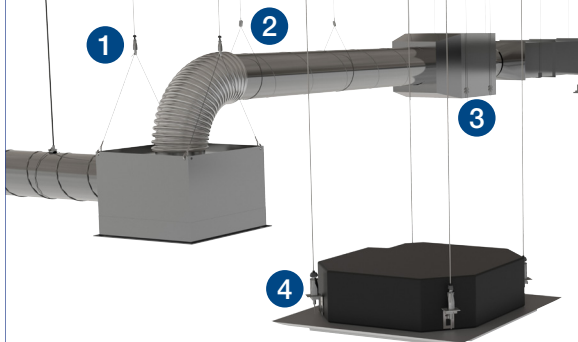

## HVAC and Mechanical Suspension Solutions

1

### Standard Hanger

Install easily for a 6X faster spiral duct installation than traditional methods.



2

### Express Hanger

A push-button release fastener for even easier height adjustments.



3

### Duct Trapeze Hanger

Your solution for fast suspension of rectangular ducting or similar services.



4

### UniGrip Range

The Next Generation of cable suspension with a range of attachment options and our highest load ratings.



[www.gripple.com](http://www.gripple.com)

## **GRIPPLE, INC.**

*(see ad page 50)*

1611 Emily Lane  
Aurora, IL 60502

**Phone:** 866-474-7753

**Fax:** 800-654-0689

**Website:** [www.gripple.com](http://www.gripple.com)

Kris Moore

*Regional Sales Manager*

Cell: 443-880-4171

Email: [k.moore@gripple.com](mailto:k.moore@gripple.com)

Will Black

*Territory Sales Manager*

Cell: 410-916-7708

Email: [w.black@gripple.com](mailto:w.black@gripple.com)

**Business Function(s):** Cable Hanger System

**- H -**

## **H&B ENGINEERED PRODUCTS, INC.**

*(see ad on page 2)*

12500 Baltimore Avenue  
Suite F  
Beltsville, MD 20705

**Phone:** 301-918-0241

**Fax:** 301-918-0242

Sean Welch

*President*

Email: [sean.welch@hbproducts.com](mailto:sean.welch@hbproducts.com)

John Abramson

Email: [john.abramson@hbproducts.com](mailto:john.abramson@hbproducts.com)

**Business Function(s):** Mechanical/Sheet Metal  
Manufacturer's Representatives

# HAVTECH AIR DISTRIBUTION, LLC

(see ad this page)

9505 Berger Road  
Columbia, MD 21046

Phone: 301-206-9225

Fax: 301-497-9610

Website: [www.havtech.com](http://www.havtech.com)

Steve Clark

*Business Development Leader*

Phone: 301-206-9225

Email: [sclark@havtech.com](mailto:sclark@havtech.com)

**Business Function(s):** Sheet Metal Products, Fans, Air Outlets, Louvers, Sound Attenuators, UL Dampers, Spiral Duct, Fiberglass Fans, American Aldes, Acoustical Panels, Venturi Valves, Under Floor Air Distribution, Ceiling Radiation Dampers, VAV Diffusers, Air Terminals, BIBO HEPA Filtration Systems, Hospital Operating Room and Ceiling Grid Systems, Remote Cable Operated Dampers, Air Curtains, X Vent Box, Flex Duct, Fabric Duct Systems, GAS Flue and Vent Systems, Vehicle Exhaust and Snorkel Systems



**HAVTECH**

**LOCAL INVENTORY**  
600+ PRODUCTS IN-STOCK

**FREE SHIPPING**  
LARGE STOCK ORDERS

**PRICE**



**POTTORFF**

**SEMCO**  
A Plastico Brand

**duravent**  
GROUP

**MAT**  
Metropolitan Air Technology

## Proudly Representing 20+ Manufacturer Lines

Serving Maryland, Washington, DC & Northern Virginia

- Registers
- Grilles & Diffusers
- Exhaust Fans
- Louvers
- Type-B Gas Vent
- Blue Duct Underground Duct
- Cable-Operated Dampers
- Fire Dampers
- Fabric Duct
- Snap-Lock & Flex-Duct
- Phenolic Ductwork

**(301) 206-9225**

COLUMBIA & CAPITOL HEIGHTS, MD

## MESTEK COMMERCIAL DAMPER LOUVER GROUP\*

(see ad this page)

450 Riverside Drive  
Wyalusing, PA 18853

**Office:** 570-746-1888

**Fax:** 570-746-9286

Mike Binkholder  
*Vice President*  
Cell: 570-637-0102

**Business Function:** Dampers



**MESTEK, INC.**  
**Commercial Damper  
& Louver Group**

450 Riverside Drive  
Wyalusing, PA 18853

Phone: 570-746-1888  
Fax: 570-746-9286

**Greg Crosby, VP**  
570-420-7048 fax: 570-420-7112  
gcrosby@mestek.com

**Mike Binkholder, VP**  
570-420-7060 fax: 570-420-7120  
mbinkholder@mestek.com

 **ARROW  
UNITED  
INDUSTRIES** [www.arrowunited.com](http://www.arrowunited.com)

**abi**  
air balance inc, [www.airbalance.com](http://www.airbalance.com)

 [www.cescoproducts.com](http://www.cescoproducts.com)

**LD** [www.louvers-dampers.com](http://www.louvers-dampers.com)

**METROPOLITAN EQUIPMENT  
GROUP, INC.**

12104 Indian Creek Court  
Suite A  
Beltsville, MD 20705

**Phone:** 240-283-0949

**Fax:** 240-283-0950

**Website:** [www.meghvac.com](http://www.meghvac.com)

Patricia King  
Direct: 301-785-2049  
Email: [pking@meghvac.com](mailto:pking@meghvac.com)

Scott Raines  
Email: [sraines@meghvac.com](mailto:sraines@meghvac.com)

**Business Function(s):** Wholesaler of HVAC  
Products, HVAC Manufacturers Rep Firm

**MILWAUKEE ELECTRIC TOOL CORP.\***

11900 Baltimore Avenue, Suite B  
Beltsville, MD 20705

**Phone:** 800-729-3878

**Fax:** 877-567-3103

**Toll Free:** 800-231-6242

**Website:** [www.milwaukeetool.com](http://www.milwaukeetool.com)

Edgar Galeano  
*Jobsite Solutions Specialist*  
*DC/Baltimore*  
Cell: 262-788-0176  
Email: [edgar.galeano@milwaukeetool.com](mailto:edgar.galeano@milwaukeetool.com)

**Business Functions(s):** Power Tool Suppliers







## **N.B. HANDY COMPANY**

*(see ad on page 42)*

7495 Race Road, Suite A  
Hanover, MD 21076

**Phone:** 443-561-9090

**Fax:** 443-561-2190

**Toll Free:** 800-231-6242

**Website:** [www.nbhandy.com](http://www.nbhandy.com)

Brian Bailey

*Sales Manager*

Email: [bbailey@nbhandy.com](mailto:bbailey@nbhandy.com)

**Business Function(s):** Distributors of Sheet Metal, Sheet Metal Fabricating Machinery, HVAC Equipment and Supplies, and Commercial Roofing Products

## **NEFCO CORPORATION**

*(see add page 56)*

1101 Hampton Park Blvd.  
Suite 300  
Capitol Heights, MD 20743

**Phone:** 800-969-0285

**Website:** [www.GoNefco.com](http://www.GoNefco.com)

Jay Livak

*Mid-Atlantic Sales Director*

Email: [jay.livak@nefcocorp.com](mailto:jay.livak@nefcocorp.com)

**Business Function(s):** Stocking Distributor of various types of Strut, Threaded Rod, Pipe Hangers, Fasteners, Tools, Anchors, Safety Supplies and Onsite Supplies for the Professional Contractor



## **OLD DOMINION SUPPLY, INC./ FERGUSON HVAC**

6945 San Tomas Road, Suite 1-Q  
Elkridge, MD 21075

**Phone:** 410-796-1284

**Website:** [www.fergusonhvac.com](http://www.fergusonhvac.com)

John Greene

*Area Manager*

Cell: 301-399-6459

Email: [john.greene@ferguson.com](mailto:john.greene@ferguson.com)

**Business Function(s):** Suppliers of Sheet Metal, Sheet Metal Supplies, Sheet Metal Machinery and HVAC Supplies



SUPPLYING CONTRACTORS SINCE 1981

**S.H.A.R.P.**<sup>®</sup>

STRUT • HARDWARE • ANCHORS • ROD • PIPE HANGERS



**DAILY SERVICE TO  
DC METRO,  
MD & VA**

**1101 HAMPTON PARK BLVD.,  
SUITE 300  
CAPITOL HEIGHTS, MD 20743**

**GONEFCO.COM**

**800-969-0285**



## **SAM DESANTO COMPANY, INC.**

*(see ad on inside back cover)*

14628 Rothgeb Drive  
Rockville, MD 20850

**Phone:** 301-424-9510

**Fax:** 301-424-9515

Jeff DeSanto

Email: [jdesanto@samdesanto.com](mailto:jdesanto@samdesanto.com)

**Business Function(s):** HVAC Supplies

## **SECTURASOFT**

11006 Reading Road  
Cincinnati, OH 45241

**Phone:** 844-637-8371

**Email:** [sales@secturasoft.com](mailto:sales@secturasoft.com)

**Website:** [secturasoft.com](http://secturasoft.com)

Brad Stropes

*VP of Sales and Marketing*

Cell: 513-545-4418

Email: [brad.stropes@secturasoft.com](mailto:brad.stropes@secturasoft.com)

Emily Shuey

*Marketing Manager*

Office: 513-268-6644

Email: [emily.shuey@secturasoft.com](mailto:emily.shuey@secturasoft.com)

**Business Function(s):** Quoting and Estimating  
for Metal Fabrication and Secondary Operations,  
Software Training, ERP Integrations.



## **ULLICO INVESTMENT COMPANY, LLC**

*(see ad on page 59)*

8403 Colesville Road  
Silver Spring, MD 20910

**Website:** [www.ullico.com](http://www.ullico.com)

Joseph Linehan

*President*

Phone: 202-682-6684

Email: [jlinehan@ullico.com](mailto:jlinehan@ullico.com)

Patrick White

Phone: 617-501-1667

Email: [pwhite@ullico.com](mailto:pwhite@ullico.com)

**Business Function(s):** Investment Products



## **VICON MACHINERY/PLASMA AUTOMATION, INC.\***

*(see ad on page 60)*

1801 Arctic Avenue  
Bohemia, NY 11716

**Website:** [www.plasma-automation.com](http://www.plasma-automation.com)

Tim Walsh

Cell: 516-375-6002

Email: [twalsh@plasma-automation.com](mailto:twalsh@plasma-automation.com)

Kevin Baydar

Cell: 908-256-3111

Email: [kbaydar@plasma-automation.com](mailto:kbaydar@plasma-automation.com)

**Business Function(s):** HVAC Machinery  
Manufacturing, Plasma & Liner cutting systems, Coil  
Lines

# ULLICO IS PROUD TO SUPPORT **SMACNA MID-ATLANTIC CHAPTER**

---

Ullico's mission is to serve, support and protect workers. Our insurance and investment solutions help protect unions and their families, rebuild communities, and create jobs.

**Patrick White**

*Director, Institutional Sales*

Ullico Investment Company, LLC  
(Member FINRA/SIPC)

Ullico Investment Advisors, Inc.

617.501.1667

[pwhite@ullico.com](mailto:pwhite@ullico.com)



**DISCOVER  
THE DIFFERENCE**

**Ullico**

[ULLICO.COM](http://ULLICO.COM)

# VICON

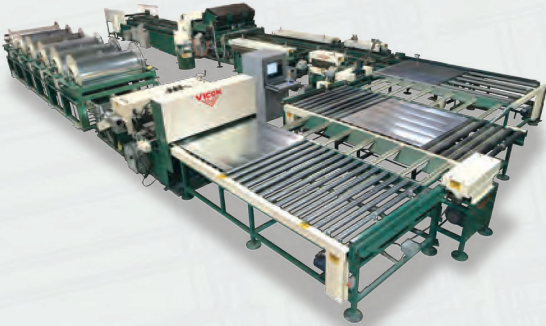

*100% Designed, Engineered,  
Manufactured and  
Supported in the USA.*

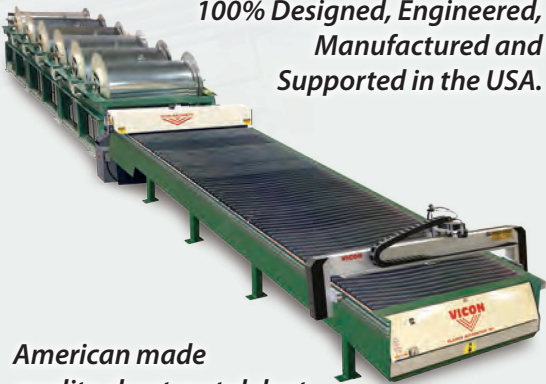

*American made  
quality sheet metal duct  
fabrication equipment and  
superior customer service.*



Vicon Machinery / Plasma Automation Inc.

[www.viconmachinery.com](http://www.viconmachinery.com)

631-563-7234

1801 Arctic Ave, Bohemia, NY 11716

# Alphabetical Personnel Index

## — A —

<b>Abramson, John</b>	<i>H&amp;B Engineered Products, Inc.</i>
<b>Adair, Charles</b>	<i>W.E. Bowers</i>
<b>Aley, Darren R.</b>	<i>Comfort Control, Inc.</i>
<b>Aley, Tim</b>	<i>W.E. Bowers</i>
<b>Amato Sr., Michael</b>	<i>Camden Yards Steel Company</i>
<b>Anderson, Vic</b>	<i>Metro Mechanical Contractors</i>
<b>Austin, Bryan</b>	<i>Densel Company</i>

## — B —

<b>Bailey, Brian</b>	<i>N.B. Handy Company</i>
<b>Baker, Gary</b>	<i>W.E. Bowers</i>
<b>Battaglino, Frank</b>	<i>Metro Test &amp; Balance, Inc.</i>
<b>Battaglino, Frank Louis</b>	<i>Metro Test &amp; Balance, Inc.</i>
<b>Battaglino, Gabriel</b>	<i>Metro Test &amp; Balance, Inc.</i>
<b>Baydar, Kevin</b>	<i>Vicon Machinery / Plasma Automation, Inc.</i>
<b>Bigelow, Kathleen</b>	<i>Comfort Control, Inc.</i>
<b>Binkholder, Mike</b>	<i>Mestek Commercial Damper Louver Group</i>
<b>Black, Will</b>	<i>Gripple, Inc.</i>
<b>Blank, Billy</b>	<i>Stromberg Metal Works, Inc.</i>
<b>Boo, David</b>	<i>PTL Contracting, LLC</i>
<b>Boo, Sam</b>	<i>PTL Contracting, LLC</i>
<b>Bowers, Wayne</b>	<i>W.E. Bowers</i>
<b>Brackett, Harvey</b>	<i>I &amp; B Associates, Inc.</i>
<b>Brewer, Jason</b>	<i>Metro Test &amp; Balance, Inc.</i>
<b>Brissey, Travis</b>	<i>W.E. Bowers</i>
<b>Brakeall, Greg</b>	<i>W.E. Bowers</i>
<b>Bruening, Matt</b>	<i>Southland Industries</i>
<b>Bryant, Chris</b>	<i>W.E. Bowers</i>

## — C —

<b>Cain, Cody</b>	<i>W.E. Bowers</i>
<b>Castle, Chris</b>	<i>MECCO, LLC</i>
<b>Clark, Steve</b>	<i>Havtech Air Distribution, LLC</i>
<b>Cohen, Roy</b>	<i>Cohen Seglias Pallas Greenhall &amp; Furman PC</i>
<b>Colburn, Kenny</b>	<i>W.E. Bowers</i>
<b>Cruz, Paul</b>	<i>W.E. Bowers</i>

**- D -**

**Dailey, Maleeta**  
**Delawder, Rob**  
**DeSanto, Jeff**  
**Devan, Jamie**  
**Duckworth, Ian**

*CMC Sheet Metal*  
*Southland Industries*  
*Sam DeSanto Company*  
*Southland Industries*  
*CMC Sheet Metal*

**- E -**

**Engels, Eric**  
**Elliott, Steve**

*Camden Yards Steel Company*  
*Stromberg Metal Works, Inc.*

**- F -**

**Finch, Paul**  
**Fleischer, Stan**  
**Fowble, Bill**  
**Fulford, Michael**

*W.E. Bowers*  
*Seneca Balance of Maryland, Inc.*  
*CMC Sheet Metal*  
*MECCO, LLC*

**- G -**

**Galeano, Edgar**  
**Gatton, Robert**  
**Gawne, Michael**  
**Gawne, William**  
**Gibson, Stewart**  
**Greene, John**

*Milwaukee Electric Tool Corp.*  
*W.E. Bowers*  
*Stromberg Metal Works, Inc.*  
*Stromberg Metal Works, Inc.*  
*W.E. Bowers*  
*Old Dominion Supply, Inc./*  
*Ferguson HVAC*

**- H -**

**Hammond, Don**  
**Hardesty, Ray**  
**Hutchinson, Ron**

*CMC Sheet Metal*  
*Environmental Balancing Corp.*  
*CMC Sheet Metal*

**- I -**

**Ingram, James**

*I & B Associates, Inc.*

**- J -**

**Johnson, Jeremy**  
**Jordan, Craig**

*American Testing, Inc.*  
*W.E. Bowers*

**- K -**

**Kanoff, Alan**  
**Kelleher, Jim**  
**Kelly, Christine**

*Camden Yards Steel Company*  
*Seneca Balance of Maryland*  
*American Testing, Inc.*



**Kelly, Mike** *American Testing, Inc.*  
**King, Patricia** *Metropolitan Equipment Group, Inc.*

**– L –**

**Linehan, Joseph** *Ullico Investment Company, LLC*  
**Livak, Jay** *NEFCO Corporation*  
**Longfellow, Rick** *W.E. Bowers*

**– M –**

**Mack, Steve** *MECCO, LLC*  
**Mackin, Derril** *Journeyman Mechanical Contractors*  
**Maddy, John** *W.E. Bowers*  
**Malle, Bryan** *Ample Sheet Metal, Inc.*  
**Maluchnik, Patti** *Georgetown Insurance Service  
an Alera Group Company*  
**McCartin, Jacob** *W.E. Bowers*  
**McGowan, Vince** *W.E. Bowers*  
**McMaster, Kevin** *W.E. Bowers*  
**Meacham, James** *Southland Industries*  
**Medel, Gina** *Penn Air Group, Inc.*  
**Medo, Jon W.** *Federated Insurance*  
**Menefee, Thomas W.** *Comfort Control, Inc.*  
**Miranda, Alex** *Penn Air Group, Inc.*  
**Moore, Kris** *Gripple, Inc.*  
**Moran, Michael P.** *Comfort Control, Inc.*  
**Mould, William** *Stromberg Metal Works, Inc.*  
**Mozingo, Alan** *CMC Sheet Metal*  
**Myers, Richard** *James Myers Company, Inc.*

**– N –**

**Neilson, Billy** *CMC Sheet Metal*  
**Nichols, Jackson** *Cohen Seglias Pallas  
Greenhall & Furman PC*  
**Nickerson, Steve** *CMC Sheet Metal*  
**Norair, Richard** *Norair Engineering Associates*  
**Noto, James** *Metro Test & Balance, Inc.*  
**Nunemaker, Ryan** *Ferguson HVAC –  
Lyon Conklin & Co.*

**– O –**

**O'Donnell, David** *W.E. Bowers*

## – P –

<b>Palermo, Kristi</b>	<i>Comfort Control, Inc.</i>
<b>Palermo, Jamie P.</b>	<i>Comfort Control, Inc.</i>
<b>Pantele, Mike</b>	<i>R.S. Harritan &amp; Co., Inc.</i>
<b>Parker, Jack</b>	<i>W.E. Bowers</i>
<b>Parsons, Andrew</b>	<i>Stromberg Metal Works, Inc.</i>
<b>Puckett, Joe</b>	<i>Stromberg Metal Works, Inc.</i>

## – R –

<b>Raines, Scott</b>	<i>Metropolitan Equipment Group, Inc.</i>
<b>Ramey, Randy</b>	<i>CMC Sheet Metal</i>
<b>Ray, Pat</b>	<i>Stromberg Metal Works, Inc.</i>
<b>Reynolds, Chris</b>	<i>Stromberg Metal Works, Inc.</i>
<b>Richardson, Rick</b>	<i>Metro Test &amp; Balance, Inc.</i>
<b>Riggs, Scott</b>	<i>W.E. Bowers</i>
<b>Robbins, Billy</b>	<i>Metro Test &amp; Balance, Inc.</i>
<b>Robbins, Chris</b>	<i>Metro Test &amp; Balance, Inc.</i>
<b>Roberts, Frank</b>	<i>Southland Industries</i>
<b>Roberts, George</b>	<i>W.E. Bowers</i>
<b>Rodriguez, Miguel</b>	<i>Penn Air Group, Inc.</i>
<b>Rossetto, Patrick</b>	<i>Duro Dyne Corp.</i>

## – S –

<b>Seglias, Ed</b>	<i>Cohen Seglias Pallas Greenhall &amp; Furman PC</i>
<b>Shahryary, Kian</b>	<i>Capital Energy Equipment, Inc.</i>
<b>Shahryary, Linda</b>	<i>Capital Energy Equipment, Inc.</i>
<b>Shahryary, Tom</b>	<i>Capital Energy Equipment, Inc.</i>
<b>Sheppard, Dale</b>	<i>W.E. Bowers</i>
<b>Sheppard, Scott</b>	<i>W.E. Bowers</i>
<b>Shuey, Emily</b>	<i>SecturaSOFT</i>
<b>Simmons, Matt</b>	<i>Georgetown Insurance Service an Alera Group Company</i>
<b>Simpson, Jason</b>	<i>W.E. Bowers</i>
<b>Sinclair, Daniel</b>	<i>Cadvantage Drafting Service, Inc.</i>
<b>Sinclair, Mary</b>	<i>Cadvantage Drafting Service, Inc.</i>
<b>Smith, Eric</b>	<i>W.E. Bowers</i>
<b>So, Andrew</b>	<i>Capital Energy Equipment, Inc.</i>
<b>Solimani, Rich</b>	<i>Duro Dyne Corp.</i>

<b>Sorna, John</b>	<i>Ductmate Industries</i>
<b>St. John, Gary</b>	<i>CMC Sheet Metal</i>
<b>Stapleton, Tony</b>	<i>Journeyman Mechanical Contractor</i>
<b>Stauffer, Mike</b>	<i>W.E. Bowers</i>
<b>Stropes, Brad</b>	<i>SecturaSOFT</i>
<b>Suhr, Mary Patricia</b>	<i>Stromberg Metal Works, Inc.</i>

## — T —

<b>Taylor, Ervin</b>	<i>W.E. Bowers</i>
<b>Trunnell, Dale</b>	<i>Metro Mechanical Contractors</i>
<b>Twigg, Thomas</b>	<i>Arica Consulting &amp; Contracting</i>

## — V —

<b>Valdisera, Justin</b>	<i>Stromberg Metal Works, Inc.</i>
<b>Vendemia, Nick</b>	<i>CMC Sheet Metal</i>

## — W —

<b>Wade, Darrell</b>	<i>W.E. Bowers</i>
<b>Walsh, Tim</b>	<i>Vicon Machinery / Plasma Automation, Inc.</i>
<b>Weatherby, Jason</b>	<i>Craftcorps, Inc.</i>
<b>Weiss, Arnold</b>	<i>W.E. Bowers</i>
<b>Welch, Sean</b>	<i>H&amp;B Engineered Products, Inc.</i>
<b>Wells, Dan</b>	<i>MECCO, LLC</i>
<b>White, Daniel</b>	<i>W.E. Bowers</i>
<b>White, Patrick</b>	<i>Ullico Investment Company, LLC</i>
<b>Whiting, Kenny</b>	<i>W.E. Bowers</i>
<b>Willoughby, Jason</b>	<i>W.E. Bowers</i>

## — Y —

<b>Yates, Alex</b>	<i>Metro Test &amp; Balance, Inc.</i>
<b>Yazel, Kristi</b>	<i>Ample Sheet Metal, Inc.</i>
<b>Yeager, Ray</b>	<i>Ductmate Industries</i>



**CAPITAL ENERGY  
EQUIPMENT, INC.**

HVAC &  
SHEET METAL  
PRODUCTS

We're an  
experienced,  
knowledgeable,  
friendly, and  
professional  
sales team.

### AIR-YNX

Pressure independent  
airflow regulator

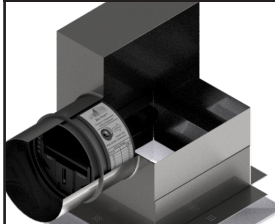

### ANEMOSTAT

Register, grilles, and  
diffusers

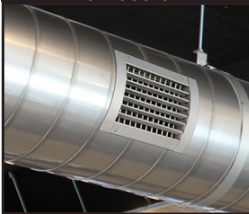

### ICC

Chimney & Flue



**(703) 437-8161**

[info@capitalenergyequipment.com](mailto:info@capitalenergyequipment.com)

[www.capitalenergyequipment.com](http://www.capitalenergyequipment.com)

Contact us today for project design assistance,  
equipment information, parts, or pricing.

### KINETIC NOISE CONTROL

Round and square silencers, acoustical louvers,  
and panels



# Members by Business Specialty

## Air Products

Capital Energy Equipment, Inc.  
H&B Engineered Products, Inc.  
Havtech Air Distribution, LLC  
Metropolitan Equipment Group, Inc.  
N.B. Handy Company  
Penn Air Control, Inc.

## Air Testing & Balancing / Commissioning

American Testing, Inc.  
Comfort Control, Inc.  
Environmental Balancing Corporation  
Metro Test & Balance, Inc.  
Penn Air Control, Inc.  
Seneca Balance of Maryland, Inc.

## Architectural HVAC

H&B Engineered Products, Inc.  
James Myers Company, Inc.  
Journeyman Mechanical Contractors  
Metropolitan Equipment Group, Inc.  
Stromberg Metal Works, Inc.  
W.E. Bowers

## BIM/CAD/Design & Drafting

Cadvantage Drafting Service, Inc.  
W.E. Bowers

## Cable Hanger Systems

Gripple, Inc.  
N.B. Handy Company  
NEFCO Corporation

## Carbon Flat Rolled Steel Sheet Metal, Plate Coil and Slit Coil

Camden Yards Steel Company  
N.B. Handy Company

## Coil Lines

N.B. Handy Company  
Vicon Machinery/Plasma Automation, Inc.

## Commercial HVAC

American Metal Goods, Inc.  
Ample Sheet Metal, Inc.  
Arica Consulting & Contracting  
CMC Sheet Metal  
Comfort Control, Inc.

Craftcorps, Inc.  
Densel Company  
H&B Engineered Products, Inc.  
Havtech Air Distribution, LLC  
I & B Associates, Inc.  
Journeyman Mechanical Contractors  
MECCO, LLC  
Metropolitan Equipment Group, Inc.  
Norair Engineering Associates  
Penn Air Control, Inc.  
R.S. Harritan & Company, Inc.  
Sam DeSanto Company  
Southland Industries  
Stromberg Metal Works, Inc.  
W.E. Bowers

## **Commercial & Industrial Piping**

Journeyman Mechanical Contractors  
R.S. Harritan & Company, Inc.  
Southland Industries  
W.E. Bowers

## **Construction Law**

Cohen Seglias Pallas Greenhall & Furman PC

## **Custom Fabrication**

Ample Sheet Metal, Inc.  
Arica Consulting & Contracting  
CMC Sheet Metal  
Metro Test & Balance, Inc.  
NEFCO Corporation  
R.S. Harritan & Company, Inc.  
W.E. Bowers

## **Dampers**

American Metal Goods, Inc.  
Arrow / Mestek Commercial Damper Louver Group  
Capital Energy Equipment, Inc.  
H&B Engineered Products, Inc.  
Havtech Air Distribution, LLC  
Metropolitan Equipment Group, Inc.

## **Diffusers**

American Metal Goods, Inc.  
Capital Energy Equipment, Inc.  
H&B Engineered Products, Inc.  
Havtech Air Distribution, LLC

## **Duct Construction**

American Metal Goods, Inc.  
Ample Sheet Metal, Inc.  
Arica Consulting & Contracting  
Capital Energy Equipment, Inc.  
CMC Sheet Metal  
Havtech Air Distribution, LLC

Journeyman Mechanical Contractors  
Metro Mechanical Contractors  
Metro Test & Balance, Inc.  
Metropolitan Equipment Group, Inc.  
N.B. Handy Company  
Stromberg Metal Works, Inc.  
W.E. Bowers

## **Estimating Software**

SecturaSOFT

## **Fire, Life & Safety Inspection**

CMC Sheet Metal  
Comfort Control, Inc.  
Metro Test & Balance, Inc.  
Seneca Balance of Maryland, Inc.  
Southland Industries  
W.E. Bowers

## **HVAC & Sheet Metal Machinery**

Ample Sheet Metal, Inc.  
Arica Consulting & Contracting  
Ferguson HVAC – Lyon Conklin & Co.  
N.B. Handy Company  
Old Dominion Supply, Inc.  
Vicon Machinery/Plasma Automation, Inc.

## **HVAC Components & Equipment**

American Metal Goods, Inc.  
American Testing, Inc.  
Ample Sheet Metal, Inc.  
Arica Consulting & Contracting  
Capital Energy Equipment, Inc.  
Ductmate Industries  
Duro Dyne Corp.  
Ferguson HVAC – Lyon Conklin & Co.  
Havtech Air Distribution, LLC  
MECCO, LLC  
N.B. Handy Company  
NEFCO Corporation  
Old Dominion Supply, Inc.  
Sam DeSanto Company

## **Industrial / Commercial Sheet Metal**

Ample Sheet Metal, Inc.  
Camden Yards Steel Company  
Craftcorps, Inc.  
Duro Dyne Corporation  
H&B Engineered Products, Inc.  
Journeyman Mechanical Contractors  
Metro Test & Balance, Inc.  
N.B. Handy Company  
Norair Engineering Associates

R.S. Harritan & Company, Inc.  
W.E. Bowers

## **Insurance / Investment Products**

Federated Insurance Company  
Georgetown Insurance Service an Alera Group Co.  
Ullico Investment Company, LLC

## **Kitchen Equipment**

Metropolitan Equipment Group, Inc.  
Penn Air Control, Inc.

## **Louvers**

American Metal Goods, Inc.  
Arrow / Mestek Commercial Damper Louver Group  
Capital Energy Equipment, Inc.  
H&B Engineered Products, Inc.  
Havtech Air Distribution, LLC  
Metropolitan Equipment Group, Inc.  
N.B. Handy Company

## **Manufacturer's Representative**

Ferguson HVAC – Lyon Conklin & Co.  
H&B Engineered Products, Inc.  
Havtech Air Distribution, LLC  
Metropolitan Equipment Group, Inc.  
NEFCO Corporation  
Sam DeSanto Company

## **Manufacturing (HVAC Components)**

Arica Consulting & Contracting  
Arrow / Mestek Commercial Damper Louver Group  
W.E. Bowers

## **Mechanical**

Arica Consulting & Contracting  
H&B Engineered Products, Inc.  
Metro Test & Balance, Inc.  
W.E. Bowers

## **Millwright Equipment Installation**

R.S. Harritan & Company, Inc.

## **Plasma & Liner Cutting Systems**

N.B. Handy Company  
Vicon Machinery/Plasma Automation, Inc.

## **Power Tool Supplies**

Milwaukee Electric Tool Corp.  
NEFCO Corporation



## **Residential Heating**

Comfort Control, Inc.  
Densel Company  
N.B. Handy Company

## **Roofing**

PTL Contracting, LLC  
James Myers Company, Inc.  
Journeyman Mechanical Contractors  
N.B. Handy Company

## **Services**

Cadvantage Drafting Service, Inc.  
Journeyman Mechanical Contractors  
SecturaSOFT  
Southland Industries  
W.E. Bowers

## **Sound & Vibration**

Arrow / Mestek Commercial Damper Louver Group  
Comfort Control, Inc.  
H&B Engineered Products, Inc.  
Metro Test & Balance, Inc.  
Metropolitan Equipment Group, Inc.  
Seneca Balance of Maryland, Inc.

## **Specialty Products**

American Testing, Inc.  
Camden Yards Steel Company  
Capital Energy Equipment, Inc.  
Ductmate Industries  
PTL Contracting, LLC  
Havtech Air Distribution, LLC  
Metro Test & Balance, Inc.  
N.B. Handy Company  
Southland Industries  
W.E. Bowers

## **Structural Steel**

NEFCO Corporation  
R.S. Harritan & Company, Inc.



# **ADR** Collectively Bargained Workers' Comp Program for Employers of Union Workers

## **10% off** Chesapeake Employers' base rates\*

Chesapeake Employers' Insurance Company proudly offers the Alternative Dispute Resolution (ADR) Collectively Bargained Workers' Compensation Program to qualifying employers of signatory local union workers. It's an exclusive workers' compensation insurance program featuring a 10% premium discount and expert safety services with the goal of helping you enhance workplace safety.

**Connect with your agent or visit [www.ceiwc.com](http://www.ceiwc.com) to get a quote today**



#### **Minimum eligibility requirements**

\*Exclusively available to employers of union workers. Participants of the program must employ workers of a signatory local union from the Baltimore Building and Construction Trades Council, Washington, D.C. Building and Construction Trades Council, or Western Maryland Building and Construction Trades Council prior to the inception date of the policy. Available for Maryland-based employers. Other eligibility requirements apply.